

# Flashing Alarm Light



Part No.: MX25F



The Ingram MX25F is a UL Type 3, 3R, 4, 4X, 12, 13 low cost flashing alarm light suitable for heavy duty applications inside and outdoors. The lens is molded from tough shatter resistant GE Lexan. This light is particularly useful in areas with high ambient noise levels where an audible signal may not be heard.

## Features

- UL Recognized for use with UL NEMA Type 3, 3R, 4, 4X, 12 and 13 enclosures (E121431)
- Lens molded from GE Lexan that is shatter resistant and UV stabilized
- Top mounted gives 360 degree visibility
- Easy to install - One hole to punch
- Hose down proof
- Available in red or amber

## Technical Specifications

- Voltage: 120VAC
- Current Draw: .21 Amps max.
- 12 and 24 Volt available for special order
- Supplied with 25 watt bulb
- Supplied with Ingrams SSF150W solid state flasher

\*The MX25F must be used with Ingram's SSF150W flasher in order to comply with UL requirements.

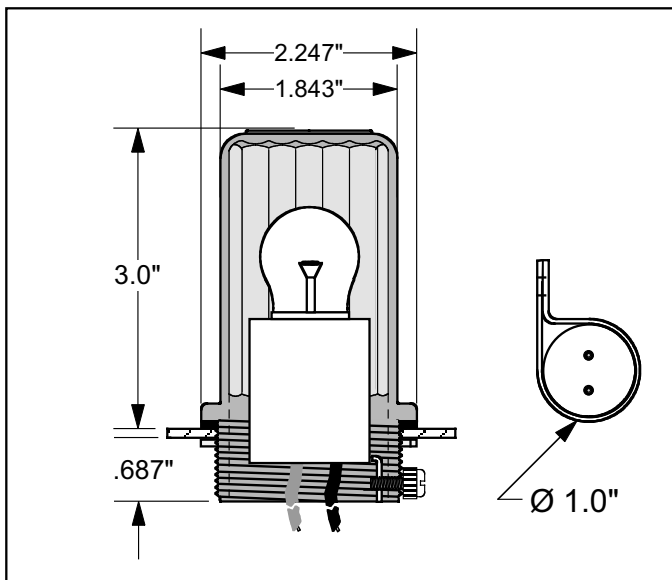

Cut-Away View

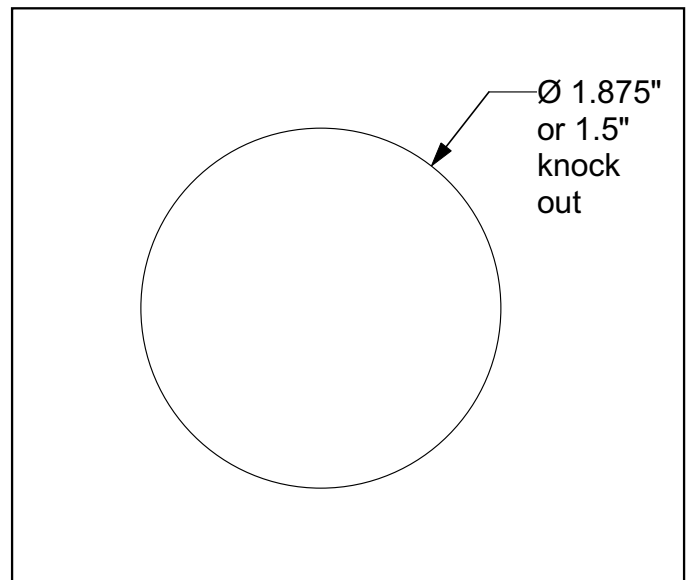

Hole Pattern For Mounting

Shatter Resistant  
G.E. Lexan Globe

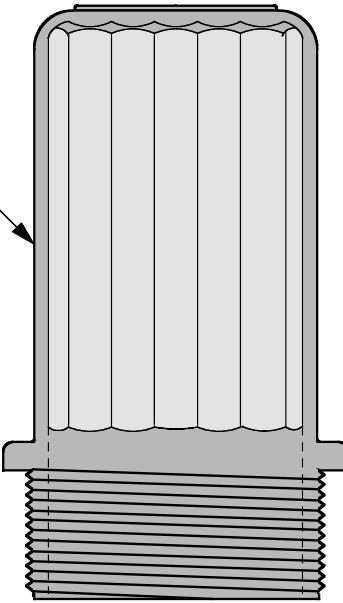

Gasket

Nylon Thumb  
Screw

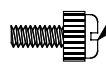

Enclosure Wall

.250" Max

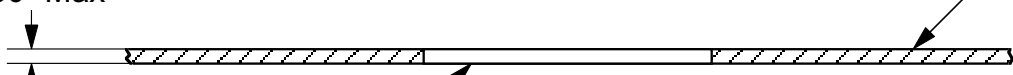

1.5" knock out  
or 1.875 Hole

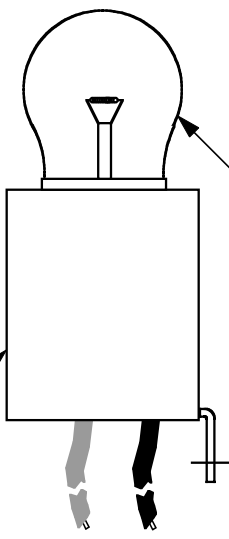

15 Watt Bulb

Socket with 36"  
Wire leads

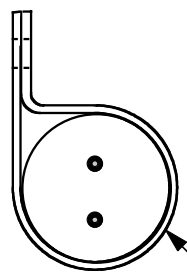

SSF150W Flasher

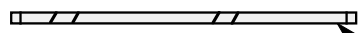

Locknut

MX25F Assembly